

FG SERIES

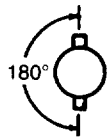
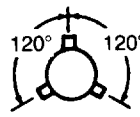
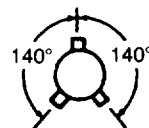
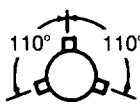
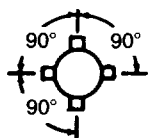

**SPECIALTY
CONNECTOR CO., INC.**

The 'FG' series connectors are miniature bayonet locking styles that are manufactured to meet the requirements of MIL-C-25516. They are usable up to 300 megacycles and are designed for extreme environmental conditions and feature excellent cable retention properties. They are polarized in a variety of combinations by the use of different lug locations and by changing contact sex. Parts noted in the data as having nylon clamps accommodate unshielded hook up wire. Other fittings accommodate a wide range of coaxial cables.

POLARITY	CONTACT		BAYONET LOCK
	● MALE	○ FEMALE	
	PLUG	JACK	SLOT (PLUG) LUG (JACK)
A	○	●	
B	●	○	
E	○	●	
F	●	○	
J	○	●	
K	●	○	
L	○	●	
M	●	○	
N	○	●	
O	●	○	

FG SERIES

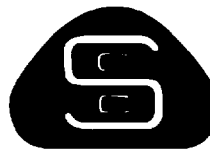

**SPECIALTY
CONNECTOR CO., INC.**

FG PLUG

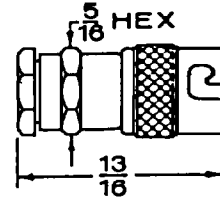

S/C Part No. by Polarity									Gasket Mtl.	Cable Range-Dia.				Engr. Data
A	B	E	F	J	K	L	M	DASH		Jacket		Ins. Max.	Cond. Max.	
										Max.	Min.			
20P100	20P101	20P102	20P103	20P104	20P105	20P106	20P107	-5	Buna-N	.095	.075	.066	.035	Gold Finish
20P100	20P101	20P102	20P103	20P104	20P105	20P106	20P107	-7	Buna-N	.095	.075	.092	.048	
20P100	20P101	20P102	20P103	20P104	20P105	20P106	20P107	-8	Buna-N	.095	.075	.108	.048	
20P100	20P101	20P102	20P103	20P104	20P105	20P106	20P107	-10	Buna-N	.115	.090	.066	.048	
20P100	20P101	20P102	20P103	20P104	20P105	20P106	20P107	-11	Buna-N	.115	.090	.071	.035	
20P100	20P101	20P102	20P103	20P104	20P105	20P106	20P107	-13	Buna-N	.115	.090	.092	.048	
20P100	20P101	20P102	20P103	20P104	20P105	20P106	20P107	-16	Buna-N	.135	.115	.092	.035	
20P100	20P101	20P102	20P103	20P104	20P105	20P106	20P107	-17	Buna-N	.135	.115	.092	.048	
20P100	20P101	20P102	20P103	20P104	20P105	20P106	20P107	-18	Buna-N	.135	.115	.108	.048	
20P100	20P101	20P102	20P103	20P104	20P105	20P106	20P107	-19	Buna-N	.150	.130	.108	.024	
20P100	20P101	20P102	20P103	20P104	20P105	20P106	20P107	-20	Buna-N	.150	.130	.108	.035	
20P110	20P111	20P112	20P113	20P114	20P115	20P116	20P117	-2	Buna-N	.065	.050	.066	.048	Gold Finish Nylon Cable Clamps for Unshielded Cable
20P110	20P111	20P112	20P113	20P114	20P115	20P116	20P117	-3	Buna-N	.080	.065	.092	.048	
20P110	20P111	20P112	20P113	20P114	20P115	20P116	20P117	-4	Buna-N	.095	.075	.092	.048	
20P110	20P111	20P112	20P113	20P114	20P115	20P116	20P117	-6	Buna-N	.115	.090	.121	.064	
20P120	20P121	20P122	20P123	20P124	20P125	20P126	20P127	-3	LS53	.095	.075	.066	.035	Rhodium Finish Brass Cable Clamps
20P120	20P121	20P122	20P123	20P124	20P125	20P126	20P127	-4	LS53	.095	.075	.066	.048	
20P120	20P121	20P122	20P123	20P124	20P125	20P126	20P127	-6	LS53	.115	.090	.071	.035	
20P120	20P121	20P122	20P123	20P124	20P125	20P126	20P127	-9	LS53	.135	.115	.092	.035	
20P120	20P121	20P122	20P123	20P124	20P125	20P126	20P127	-10	LS53	.135	.115	.108	.048	
20P130	20P131	20P132	20P133	20P134	20P135	20P136	20P137	-2	LS53	.065	.050	.066	.048	Rhodium Finish Nylon Cable Clamps for Unshielded Cable
20P130	20P131	20P132	20P133	20P134	20P135	20P136	20P137	-3	LS53	.080	.065	.092	.048	
20P130	20P131	20P132	20P133	20P134	20P135	20P136	20P137	-4	LS53	.095	.075	.092	.048	
20P130	20P131	20P132	20P133	20P134	20P135	20P136	20P137	-6	LS53	.115	.090	.121	.064	

FG PLUG

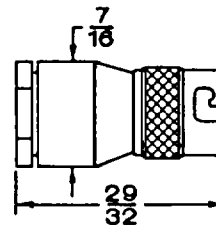

S/C Part No. by Polarity									Gasket Mtl.	Cable RG-U	
A	B	E	F	J	K	L	M	Dash			
20P158	20P188	20P186	20P187	20P151	20P152				-1	Buna-N	58
20P158	20P188	20P186	20P187	20P151	20P152				-2	Buna-N	223

FG SERIES

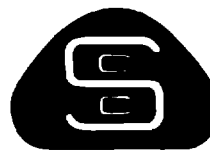

**SPECIALTY
CONNECTOR CO., INC.**

FG PLUG — RIGHT ANGLE

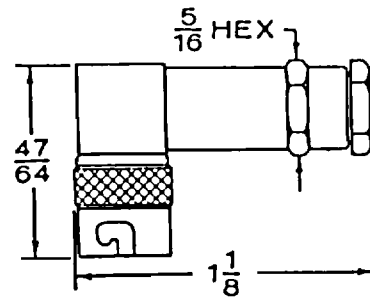
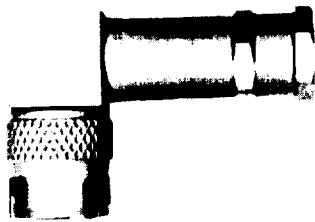

S/C Part No. by Polarity									Gasket Mtl.	Cable Range-Dia.				Engr. Data
A	B	E	F	J	K	L	M	DASH		Jacket		Ins. Max.	Cond. Max.	
										Max.	Min.			
20P160	20P161	20P162	20P163	20P164	20P165	20P166	20P167	-5	Buna-N	.095	.075	.066	.035	Gold Finish
20P160	20P161	20P162	20P163	20P164	20P165	20P166	20P167	-7	Buna-N	.095	.075	.092	.048	
20P160	20P161	20P162	20P163	20P164	20P165	20P166	20P167	-8	Buna-N	.095	.075	.108	.048	
20P160	20P161	20P162	20P163	20P164	20P165	20P166	20P167	-10	Buna-N	.115	.090	.066	.048	
20P160	20P161	20P162	20P163	20P164	20P165	20P166	20P167	-11	Buna-N	.115	.090	.071	.035	
20P160	20P161	20P162	20P163	20P164	20P165	20P166	20P167	-13	Buna-N	.115	.090	.092	.048	
20P160	20P161	20P162	20P163	20P164	20P165	20P166	20P167	-16	Buna-N	.135	.115	.092	.035	
20P160	20P161	20P162	20P163	20P164	20P165	20P166	20P167	-17	Buna-N	.135	.115	.092	.048	
20P160	20P161	20P162	20P163	20P164	20P165	20P166	20P167	-18	Buna-N	.135	.115	.108	.048	
20P160	20P161	20P162	20P163	20P164	20P165	20P166	20P167	-19	Buna-N	.150	.130	.108	.024	
20P160	20P161	20P162	20P163	20P164	20P165	20P166	20P167	-20	Buna-N	.150	.130	.108	.035	
20P170	20P171	20P172	20P173	20P174	20P175	20P176	20P177	-2	Buna-N	.065	.050	.066	.048	Gold Finish Nylon Cable Clamps for Unshielded Cable
20P170	20P171	20P172	20P173	20P174	20P175	20P176	20P177	-3	Buna-N	.080	.065	.092	.048	
20P170	20P171	20P172	20P173	20P174	20P175	20P176	20P177	-4	Buna-N	.095	.075	.092	.048	
20P170	20P171	20P172	20P173	20P174	20P175	20P176	20P177	-6	Buna-N	.115	.090	.121	.064	
20P170	20P171	20P172	20P173	20P174	20P175	20P176	20P177	-6	Buna-N	.115	.090	.121	.064	

FG PLUG — RIGHT ANGLE

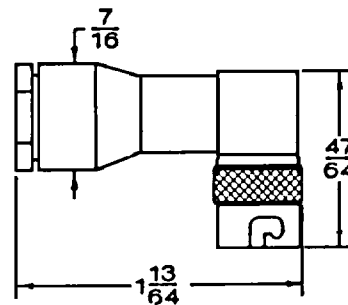
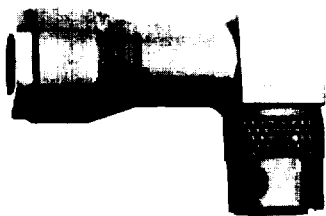

S/C Part No. by Polarity									Gasket Mtl.	Cable RG-U	
A	B	E	F	J	K	L	M	Dash			
20P192	20P193	20P194	20P195						-1	Buna-N	58

FG PLUG RECEPTACLE — SINGLE HOLE MOUNT

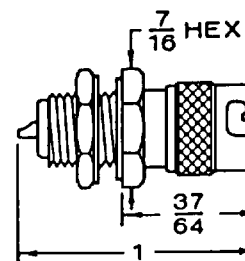

S/C Part No. by Polarity									Gasket Mtl.	Mtg. Dim.	
A	B	E	F	J	K	L	M	Dash		Hole Dia.	Panel Thkns.
20PR101	20PR102	20PR103	20PR104	20PR105	20PR106	20PR107	20PR108	-1	Buna-N	D9	3/32

FG SERIES

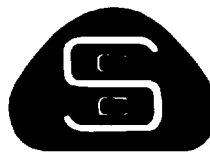

**SPECIALTY
CONNECTOR CO., INC.**

FG JACK — SINGLE HOLE MOUNT

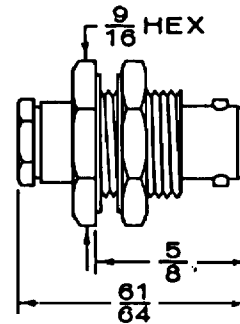

S/C Part No. by Polarity									Gasket Mtl.	Cable Range-Dia.				Mtg. Hole	Dim. Panel Thkns.	Engr. Data
A	B	E	F	J	K	L	M	DASH		Jacket		Ins. Max.	Cond. Max.			
										Max.	Min.					
20JS100	20JS101	20JS102	20JS103	20JS104	20JS105	20JS106	20JS107	-3	Buna-N	.095	.075	.066	.035	C1	7/32	Gold Finish Brass Cable Clamps
20JS100	20JS101	20JS102	20JS103	20JS104	20JS105	20JS106	20JS107	-5	Buna-N	.095	.075	.092	.048	C1	7/32	
20JS100	20JS101	20JS102	20JS103	20JS104	20JS105	20JS106	20JS107	-7	Buna-N	.115	.090	.066	.048	C1	7/32	
20JS100	20JS101	20JS102	20JS103	20JS104	20JS105	20JS106	20JS107	-8	Buna-N	.115	.090	.071	.035	C1	7/32	
20JS100	20JS101	20JS102	20JS103	20JS104	20JS105	20JS106	20JS107	-9	Buna-N	.115	.090	.092	.035	C1	7/32	
20JS100	20JS101	20JS102	20JS103	20JS104	20JS105	20JS106	20JS107	-11	Buna-N	.135	.115	.092	.035	C1	7/32	
20JS100	20JS101	20JS102	20JS103	20JS104	20JS105	20JS106	20JS107	-12	Buna-N	.135	.115	.092	.048	C1	7/32	
20JS100	20JS101	20JS102	20JS103	20JS104	20JS105	20JS106	20JS107	-13	Buna-N	.135	.115	.108	.048	C1	7/32	
20JS100	20JS101	20JS102	20JS103	20JS104	20JS105	20JS106	20JS107	-14	Buna-N	.150	.130	.108	.024	C1	7/32	
20JS100	20JS101	20JS102	20JS103	20JS104	20JS105	20JS106	20JS107	-15	Buna-N	.150	.130	.108	.035	C1	7/32	
20JS110	20JS111	20JS112	20JS113	20JS114	20JS115	20JS116	20JS117	-2	Buna-N	.065	.050	.066	.048	C1	7/32	
20JS110	20JS111	20JS112	20JS113	20JS114	20JS115	20JS116	20JS117	-3	Buna-N	.080	.065	.092	.048	C1	7/32	
20JS110	20JS111	20JS112	20JS113	20JS114	20JS115	20JS116	20JS117	-4	Buna-N	.095	.075	.092	.048	C1	7/32	
20JS110	20JS111	20JS112	20JS113	20JS114	20JS115	20JS116	20JS117	-6	Buna-N	.115	.090	.121	.064	C1	7/32	
20JS120	20JS121	20JS122	20JS123	20JS124	20JS125	20JS126	20JS127	-3	LS53	.095	.075	.066	.035	C1	7/32	
20JS120	20JS121	20JS122	20JS123	20JS124	20JS125	20JS126	20JS127	-4	LS53	.095	.075	.066	.048	C1	7/32	
20JS120	20JS121	20JS122	20JS123	20JS124	20JS125	20JS126	20JS127	-6	LS53	.115	.090	.071	.035	C1	7/32	
20JS120	20JS121	20JS122	20JS123	20JS124	20JS125	20JS126	20JS127	-9	LS53	.135	.115	.092	.035	C1	7/32	
20JS120	20JS121	20JS122	20JS123	20JS124	20JS125	20JS126	20JS127	-10	LS53	.135	.115	.108	.048	C1	7/32	
20JS131	20JS132	20JS133	20JS134	20JS135	20JS136	20JS137	20JS138	-5	Buna-N	.095	.075	.066	.035	D8	7/32	
20JS131	20JS132	20JS133	20JS134	20JS135	20JS136	20JS137	20JS138	-7	Buna-N	.095	.075	.092	.048	D8	7/32	
20JS131	20JS132	20JS133	20JS134	20JS135	20JS136	20JS137	20JS138	-8	Buna-N	.095	.075	.108	.048	D8	7/32	
20JS131	20JS132	20JS133	20JS134	20JS135	20JS136	20JS137	20JS138	-10	Buna-N	.115	.090	.066	.048	D8	7/32	
20JS131	20JS132	20JS133	20JS134	20JS135	20JS136	20JS137	20JS138	-11	Buna-N	.115	.090	.071	.035	D8	7/32	
20JS131	20JS132	20JS133	20JS134	20JS135	20JS136	20JS137	20JS138	-13	Buna-N	.115	.090	.092	.048	D8	7/32	
20JS131	20JS132	20JS133	20JS134	20JS135	20JS136	20JS137	20JS138	-16	Buna-N	.135	.115	.092	.035	D8	7/32	
20JS131	20JS132	20JS133	20JS134	20JS135	20JS136	20JS137	20JS138	-17	Buna-N	.135	.115	.092	.048	D8	7/32	
20JS131	20JS132	20JS133	20JS134	20JS135	20JS136	20JS137	20JS138	-18	Buna-N	.135	.115	.108	.048	D8	7/32	
20JS131	20JS132	20JS133	20JS134	20JS135	20JS136	20JS137	20JS138	-19	Buna-N	.150	.130	.108	.024	D8	7/32	
20JS131	20JS132	20JS133	20JS134	20JS135	20JS136	20JS137	20JS138	-20	Buna-N	.150	.130	.108	.035	D8	7/32	

FG JACK RECEPTACLE — SINGLE HOLE MOUNT (SOLDER LUG)

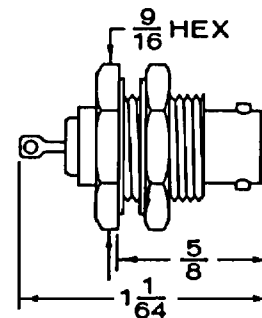
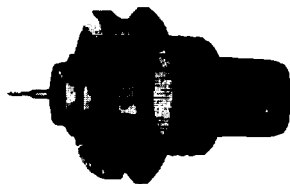

S/C Part No. by Polarity								Mtg. Dim.		Engr. Data
A	B	E	F	J	K	L	M	Mtg. Hole	Panel Thkns.	
20JR136-1	20JR137-1	20JR138-1	20JR139-1	20JR140-1	20JR141-1	20JR142-1	20JR143-1	C1	7/32	Rhodium Finish Herm. Sealed

FG SERIES



**SPECIALTY
CONNECTOR CO., INC.**

FG JACK

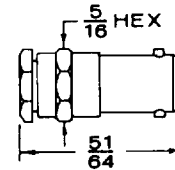

S/C Part No. by Polarity									Gasket Mtl.	Cable Range-Dia.				Engr. Data
A	B	E	F	J	K	L	M	DASH		Jacket		Ins. Max.	Cond. Max.	
										Max.	Min.			
20J105	20J106	20J107	20J108	20J109	20J110	20J111	20J112	-1	Buna-N	.095	.075	.066	.035	Gold Finish Brass Cable Clamps
20J105	20J106	20J107	20J108	20J109	20J110	20J111	20J112	-2	Buna-N	.095	.075	.108	.048	
20J105	20J106	20J107	20J108	20J109	20J110	20J111	20J112	-3	Buna-N	.115	.090	.066	.048	
20J105	20J106	20J107	20J108	20J109	20J110	20J111	20J112	-4	Buna-N	.115	.090	.108	.048	
20J105	20J106	20J107	20J108	20J109	20J110	20J111	20J112	-5	Buna-N	.135	.115	.092	.035	
20J105	20J106	20J107	20J108	20J109	20J110	20J111	20J112	-6	Buna-N	.135	.115	.108	.048	
20J113	20J114	20J115	20J116	20J117	20J118	20J119	20J120	-1	Buna-N	.065	.050	.066	.048	Gold Finish Nylon Clamps for Unshielded Cable

FG JACK RECEPTACLE — SINGLE HOLE MOUNT (SOLDER POT)

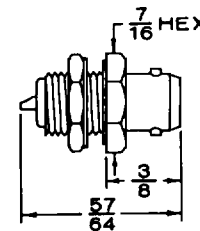

S/C Part No. by Polarity								Mtg. Dim.		Engr. Data
A	B	E	F	J	K	L	M	Mtg. Hole	Panel Thkns.	
20JR122-1	20JR123-1	20JR124-1	20JR125-1	20JR126-1	20JR127-1	20JR128-1	20JR129-1	C3	3/32	Gold Finish Pressurized

FG JACK RECEPTACLE — SOLDER MOUNT (SOLDER LUG)

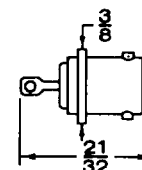

S/C Part No. by Polarity								Mtg. Dim.		Engr. Data
A	B	E	F	J	K	L	M	Mtg. Hole	Panel Thkns.	
20JR101-1	20JR102-1	20JR103-1	20JR104-1	20JR105-1	20JR106-1	20JR107-1	20JR108-1	C4	.050	Gold Finish Herm. Sealed
20JR111-1	20JR112-1	20JR113-1	20JR114-1	20JR115-1	20JR116-1	20JR117-1	20JR118-1	C4	.050	Rhodium Finish Herm. Sealed

FG SERIES



**SPECIALTY
CONNECTOR CO., INC.**

FG JUNCTION BOX

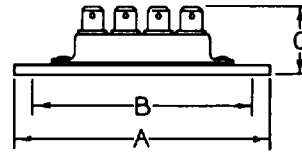

S/C Part No. by Polarity					Dimensions			Mtg. Hole	Engr. Data
A	B	E	F	No. Jacks	A	B	C		
20JB100-1	20JB101-1	20JB102-1	20JB103-1	3	3	2-1/2	57/64	3/16	} Isolated Ground
20JB104-1			20JB105-1	4	3-7/16	2-15/16	57/64	3/16	
			20JB106-1	5	3-7/8	3-3/8	57/64	3/16	
20JB107-1	20JB108-1	20JB109-1	20JB110-1	4	2-7/16	2-1/8	3/8	1/8	

FG CROSS ADAPTERS (3 JACKS, 1 PLUG)

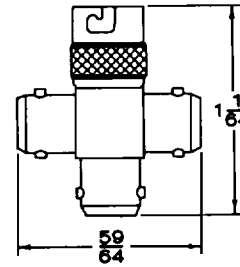
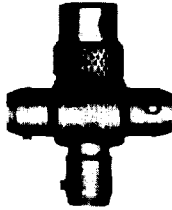

S/C Part No. by Polarity								Engr. Data
A	B	E	F	J	K	L	M	
20AC109-1	20AC110-1	20AC111-1	20AC112-1	20AC113-1	20AC114-1	20AC115-1	20AC116-1	Gold Finish

FG CROSS ADAPTERS (4 JACKS)

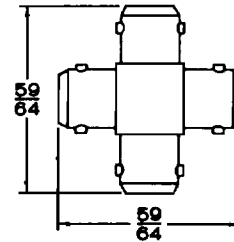
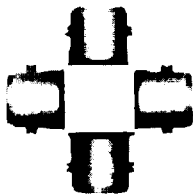

S/C Part No. by Polarity								Engr. Data
A	B	E	F	J	K	L	M	
20AC100-1	20AC101-1	20AC102-1	20AC103-1	20AC104-1	20AC105-1	20AC106-1	20AC107-1	Gold Finish

FG PLUG CAP

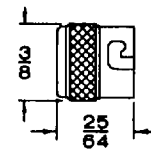

S/C Part No. by Polarity				Engr. Data
A & B	E & F	J & K	L & M	
20PC100-1	20PC101-1	20PC102-1	20PC103-1	With Chain Weatherproof
20PC104-1	20PC105-1	20PC106-1	20PC107-1	Without Chain Not Weatherproof

FG SERIES



**SPECIALTY
CONNECTOR CO., INC.**

FG ADAPTER — RIGHT ANGLE (JACK-JACK)

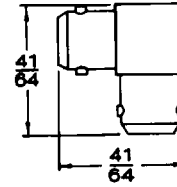
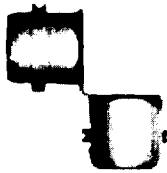

S/C Part No. by Polarity								Engr. Data
A	B	E	F	J	K	L	M	
20AR108-1	20AR109-1	20AR110-1	20AR111-1	20AR112-1	20AR113-1	20AR114-1	20AR115-1	Gold Finish

FG ADAPTER — RIGHT ANGLE (PLUG-JACK)

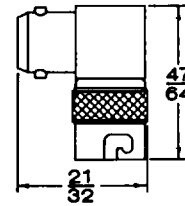
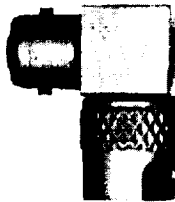

S/C Part No. by Polarity								Engr. Data
A	B	E	F	J	K	L	M	
20AR100-1	20AR101-1	20AR102-1	20AR103-1	20AR104-1	20AR105-1	20AR106-1	20AR107-1	Gold Finish

FG ADAPTER (JACK-JACK) — SINGLE HOLE MOUNT

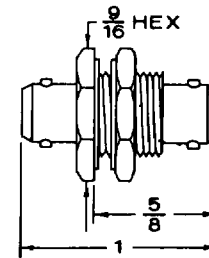

S/C Part No. by Polarity								Mtg. Dim.		Engr. Data
A	B	E	F	J	K	L	M	Mtg. Hole	Panel Thkns.	
20AS110-1	20AS111-1	20AS112-1	20AS113-1	20AS114-1	20AS115-1	20AS116-1	20AS117-1	C1	7/32	Gold Finish Herm. Sealed

FG ADAPTER TEE

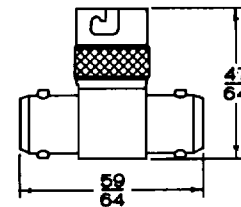
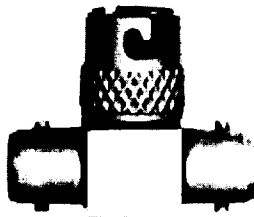

S/C Part No. by Polarity								Connector Designation	Engr. Data
A	B	E	F	J	K	L	M		
20AT100-1	20AT101-1	20AT102-1	20AT103-1	20AT104-1	20AT105-1	20AT106-1	20AT107-1	Jack-Plug-Jack	Gold Finish
20AT110-1	20AT111-1	20AT112-1	20AT113-1	20AT114-1	20AT115-1	20AT116-1	20AT117-1	Jack-Jack-Plug	
20AT120-1	20AT121-1	20AT122-1	20AT123-1	20AT124-1	20AT125-1	20AT126-1	20AT127-1	Jack-Jack-Jack	